



CARACTERÍSTICAS GENERALES:

- Tensión de salida sinusoidal
- Adecuado para el control motores
- Frecuencia salida seleccionable: 50/60Hz
- Tensión de salida ajustable
- Alto aislamiento entrada/salida 3000Vrms
- Inhibición remota
- Inversión de fases
- Control remoto RS232
- Alarma por contactos aislados de relé
- Paro remoto opto-acoplado
- Versión ferroviaria EN50155 opcional
- Fuego y humo: Aprobado EN45545-2

GENERAL FEATURES:

- Sine wave output voltage
- Suitable for motors control
- Selectable output frequency: 50/60Hz
- Adjustable output voltage
- High input-output isolation 3000Vrms
- Remote inhibit
- Reverse phase
- Remote control via RS232
- Alarm by isolated relay contacts
- Remote off opto-coupled
- Optional railway version EN50155
- Fire and smoke: EN45545-2 approved

Model	Input	Input Voltage range	Output Von	Power	Output current	Output peak current		Efficiency	No load input current
						Arms 5s	10ms (Iopk)		
7403	24 Vdc	16.8 ... 30V	400 Vac	2400 W	3.46 A	5.25 A	11 A	89 %	<1.58 A
7404	36 Vdc	25.2 ... 45V	400 Vac	3000 W	4.33 A	6.6 A	11 A	90 %	<1.05 A
7405	48 Vdc	33.6 ... 60V	400 Vac	3000 W	4.33 A	6.6 A	11 A	91 %	< 0.79 A
7406	72 Vdc	50.4 ... 90V	400 Vac	3000 W	4.33 A	6.6 A	11 A	91 %	< 0.52 A
7407	110 Vdc	77 ... 138V	400 Vac	3000 W	4.33 A	6.6 A	11 A	92 %	< 0.34 A
7413	24 Vdc	16.8 ... 30V	230 Vac	2400 W	6.0 A	9.0 A	19 A	89 %	<1.58 A
7417	110 Vdc	77 ... 138V	230 Vac	3000 W	7.55 A	11.3 A	19 A	91%	< 0.34 A

ENTRADA	INPUT	
Margen de tensión de entrada	Input voltage range	-30, +25% Vin nom
Rizado máximo a la entrada	Maximum input ripple	5% Vin nom (Vrms, 100Hz)
SALIDA	OUTPUT	
Tensión de salida nominal (Von)	Nominal output voltage (Von)	See table
Margen ajuste de salida	Output voltage range	50...100% of Von(adjust via RS-232)
Frecuencia de salida	Output frequency	50 / 60Hz via DIP-switch, 16...60Hz via RS-232
Regulación de carga	Load regulation	< 4%
Regulación de línea	Line regulation	< 2% Vin -25% ... +25%, < 10% Vin -30% ... +30%
Distorsión tensión de salida THD	Output wave distortion THD	< 2% (average of 16 samples)
Rizado de salida AF	Output HF ripple	< 2.5%
AMBIENTE	ENVIRONMENTAL	
Temperatura de almacenamiento	Storage temperature	-25 ... 80°C
Temperatura de funcionamiento:	Operating temperature:	
Plena carga	Full load	-25 ... 55°C (EN50155 T1)
50% de carga	50% load	-25 ... 70°C (EN50155 T3)
Humedad relativa sin condensación	Relative humidity without condensation	5 ... 95%
Refrigeración	Cooling	Ventilador interno controlado /Controlled internal fan
MTBF (MIL-HDBK-217-E; G _b , 25°C)	MTBF (MIL-HDBK-217-E; G _b , 25°C)	100.000 h
CEM	EMC	
Inmunidad según	Immunity according	EN61000-6-2 (EN50121-3-2)
Emisiones según	Emissions according	EN61000-6-4 (EN50121-3-2)
SEGURIDAD	SAFETY	
Rigidez dieléctrica: Entrada / salida	Dielectric strength: Input /output	3000 Vrms / 50Hz / 1min
Rigidez dieléctrica: Salida / chasis	Dielectric strength: Output / ground	1500 Vrms / 50Hz / 1min
Rigidez dieléctrica: Entrada / chasis	Dielectric strength: Input / ground	500 Vrms / 50Hz / 1min
Seguridad según	Safety according to	EN60950-1
Fuego y humo	Fire and smoke	EN45545-2
MECÁNICA	MECHANICAL	
Peso	Weight	<7150 g
PROTECCIONES	PROTECTIONS	
Contra sobrecargas	Against overloads	Current and I ² T limited (see overload protection)
Contra sobretensión	Against overtemperature	Shutdown with auto-recovery
CONTROL	CONTROL	
LED de salida correcta	Output OK LED	Verde / Green
LED de entrada correcta	Input OK LED	Verde / Green
Alarma de fallo de entrada	Input alarm	Open when alarm. Maximum rating: 0.16A at 160Vdc
Alarma de fallo de salida	Output alarm	Open when alarm. Maximum rating: 0.16A at 160Vdc
Entrada inhibición remota	Remote OFF input	Off applying 15... 143 Vdc, Impedance >35kΩ
Inversión de giro	Rotation inversion	Inversion applying 15... 143 Vdc, Impedance >35kΩ

CONEXIONES / CONNECTIONS

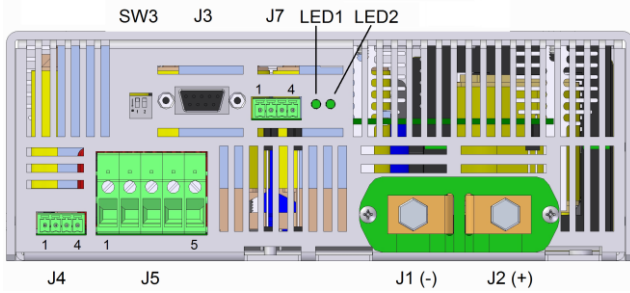

J1	-Vin	Terminals M6
J2	+Vin	
J5 - 1	Protective Earth	Cables 1.5 ... 2.5mm ²
J5 - 2	Output R	
J5 - 3	Output S	
J5 - 4	Output T	
J5 - 5	Output Neutral	Phoenix Contact MC1.5/4-G-3.81 Recommended female: Phoenix Contact MC1.5/4-ST-3.81
J4 - 1	+ Phase inversion	
J4 - 2	- Phase inversion	
J4 - 3	+ Remote ON/OFF	
J4 - 4	- Remote ON/OFF	Phoenix Contact MC1.5/4-G-3.81 Recommended female: Phoenix Contact MC1.5/4-ST-3.81
J7 - 1	Output alarm	
J7 - 2	Output alarm	
J7 - 3	Input alarm	
J7 - 4	Input alarm	Sub-DB9 female
J3 - 2	RS-232 Rx	
J3 - 3	RS-232 Tx	
J3 - 5	RS-232 GND	
J3 rest	Not connected	

DESCRIPCIÓN

La serie ODX-3000 está constituida por convertidores de corriente continua a corriente alterna sinusoidal trifásica, con aislamiento galvánico entre la entrada y la salida.

El equipo permite:

- Cambiar la frecuencia de salida mediante el DIP-switch-1 de SW3. OFF: 50Hz, ON: 60Hz
- Cambiar local / remoto (RS-232) mediante el DIP-switch-2 de SW3. OFF: local, ON: remote
- Parar la salida aplicando tensión entre 15 y 143V en los pines 3 y 4 de J4
- Arrancar motores mediante arranque suave. En el arranque, la tensión frecuencia crece linealmente de 0V a la tensión establecida y de 16Hz hasta la frecuencia establecida. La pendiente de la rampa de arranque puede ser cambiada vía RS-232
- Establecer la velocidad de rotación de un motor según la relación tensión/frecuencia adecuada.
- Cambiar el sentido de rotación de un motor aplicando tensión entre 15 y 143V en los pines 1 y 2 de J4
- Monitorizar el estado de la tensión de entrada y salida mediante los contactos de sendos relés de estado sólido.
- Establecer y monitorizar parámetros mediante el puerto RS232

El ODX-3000 cuenta con una protección de potencia media máxima y otra de corriente de pico de máxima en la salida. Esto protege a los semiconductores incluso ante cortocircuitos en la salida. Además dispone de inhibición por subtensión de entrada, lo cual, permite proteger las baterías contra descargas destructivas.

DESCRIPTION

The ODX-3000 consists of three phase sine-wave DC-AC inverters with galvanic isolation between input and output.

The unit allows:

- Changing the output frequency by means of DIP-switch-1 of SW3. OFF: 50Hz, ON: 60Hz
- Change local/remote (RS-232) by means of DIP-switch-2 of SW3. OFF: local, ON: remote
- Shutdown applying voltage output 15 to 143V on pins 3 and 4 of J4
- Start-up motors by means of a soft start. In the start-up, the output voltage and frequency rise linearly from 0V to set voltage and from 16Hz to set frequency. The start-up ramp slope may be changed via RS-232 port
- Set the rotation speed of a motor according to the appropriate Voltage/Frequency ratio.
- Changing the rotation direction of a motor by applying voltage between 15 and 143V on pins 1 and 2 of J4
- Monitoring the status of the input and output voltage through the contacts of two separate solid state relays.
- Set and monitor parameters via RS-232.

The ODX-3000 is equipped with a maximum average power protection as well as maximum output peak current protection. This protects the semiconductors even when an output short-circuit occurs. It also features a disable function for input under-voltage, which allows protecting the batteries from harmful discharges.

INSTALACIÓN

- El equipo dispone de 4 taladros roscados para el anclaje a una superficie de montaje.
- El equipo tiene ventiladores internos. Para una correcta refrigeración, la entrada y salida de aire deben estar libres de elementos que reduzcan el flujo de aire (distancia recomendada mínima a otros objetos 50mm)
- Efectuar la conexión según la figura.
- La frecuencia de salida por defecto es 50Hz. Si se requiere 60Hz actuar el dip-switch según la figura.

Por motivos de seguridad es necesario:

DIAGRAMA DE BLOQUES / BLOCKS DIAGRAM

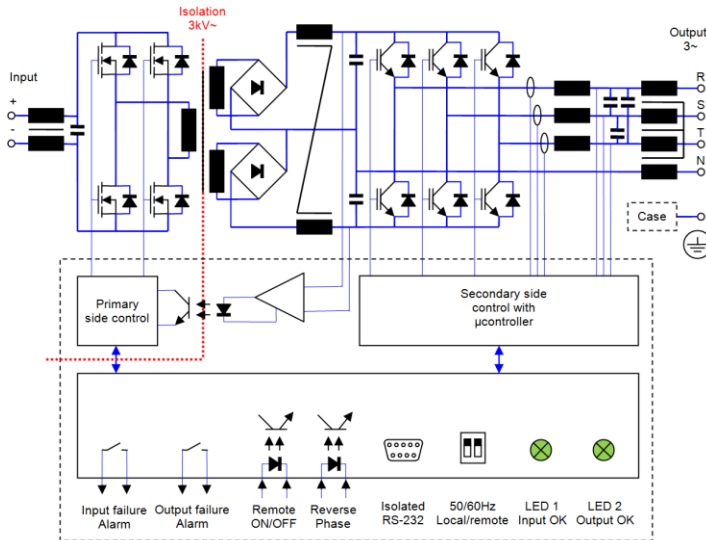

	Funciones RS232	RS232 functions
Monitoring	Tensión de entrada	Input voltage
	Tensión de salida	Output voltage
	Corriente salida	Output current
	Temperatura interna	Internal temperature
	Frecuencia de salida	Output frequency
	Potencia de salida	Output power
Settings	Paro por subtensión entrada	Input undervoltage lockout
	Alarma de subtensión entrada	Input undervoltage alarm
	Paro / macha	On / Off
	Frecuencia de salida	Output frequency
	Corriente salida máxima	Maximum output current
	Tensión de salida	Output voltage

DIMENSIONES / DIMENSIONS

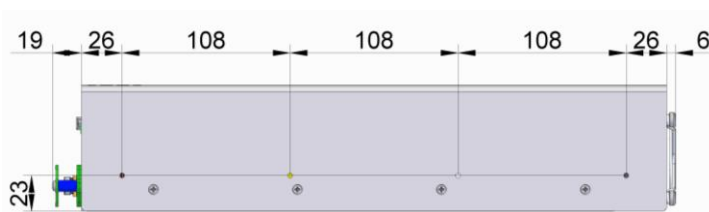
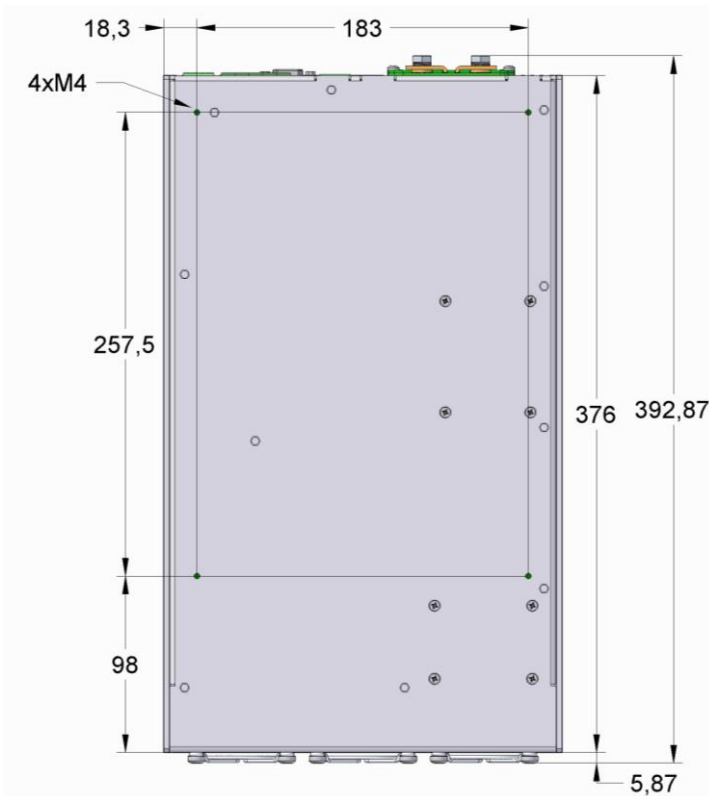
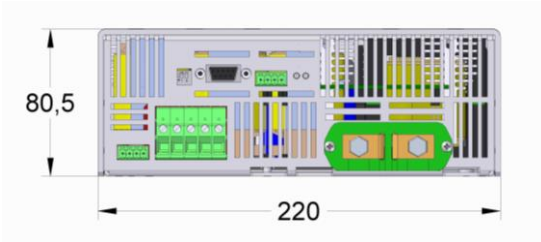

Profundidad máxima de los tornillos M4: 4.5mm
 Maximum depth for the screws M4: 4.5mm

- Proporcionar al equipo una envoltura de protección conforme a las directivas de seguridad eléctrica del país donde sea instalado.
- Incorporar un fusible a la entrada de una corriente inmediatamente superior a la corriente máxima de entrada.
- Usar conductores de sección apropiada para conectar entradas y salidas. En la tabla siguiente se muestran las corrientes máximas y las secciones mínimas de los conductores para cada una de las conexiones de potencia.

START-UP

- The unit has 4 threaded holes for the fixation on a mounting surface.
- The unit has internal fans. For an appropriate cooling, the air input and output should be free of elements that cause and an air flow reduction (minimum recommended distance to other objects 50mm).
- Make connections as shown in the figure.
- The default output frequency is 50Hz. For 60Hz simply actuate the dip-switch as indicated in the figure.

For safety reasons, the following requirements must be met:

- Provide the equipment with some kind of protective enclosure that complies with the electrical safety directives in effect within the country where the equipment is installed.
- Include an input fuse with a rating immediately higher than the maximum input current.
- Use cables of adequate cross-section to connect inputs and outputs. The following table lists the maximum currents and the minimum cross-sections for the cables used for each power connection.

	Input 24V	Input 36V	Input 48V	Input 72V	Input 110V	Output 230V	Output 400V
Maximum current	140 A	130 A	100 A	66 A	44 A	6 A	4.3 A
Cable cross-section	50 mm ²	50 mm ²	25 mm ²	16 mm ²	10 mm ²	1.5 mm ²	1.5 mm ²

OPCIONES	CÓDIGO DE PEDIDO
VERSION INDUSTRIAL	ODX-3000-74XX-B
VERSION FERROVIARIA	ODX-3000-74XX-T
OPTIONS	ORDERING CODE
INDUSTRIAL VERSION	ODX-3000-74XX-B
RAILWAY VERSION	ODS-3000-74XX-T

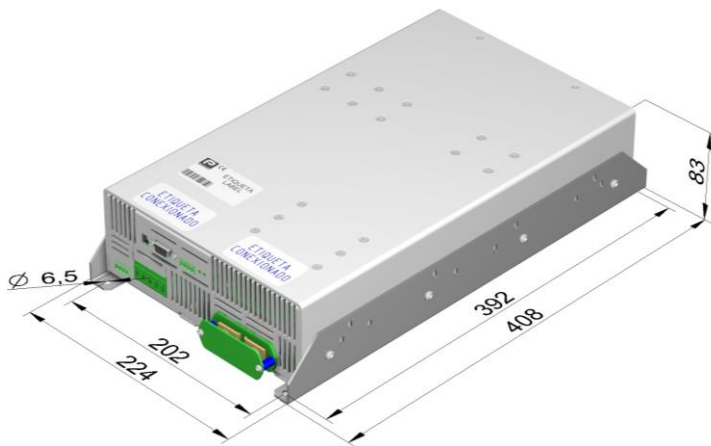

NP-9282

ACCESORIOS	CÓDIGO
Kit escuadras de montaje Contiene dos escuadras y tornillos	NP-9282
Kit bandeja para rack 19" de 2U. Permite alojar una o dos unidades.	NP-9353
ACCESSORIES	CODE
Mounting brackets kit Contains baseplate	NP-9282
2U 19" rackmount tray kit. It allows to install one or two ODS-3000	NP-9353

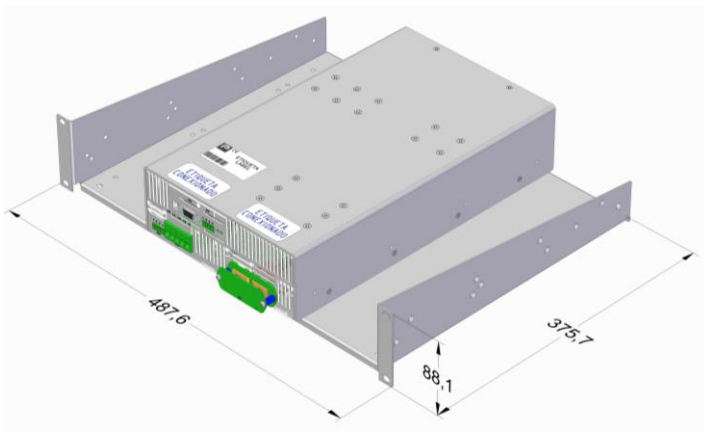

NP-9353

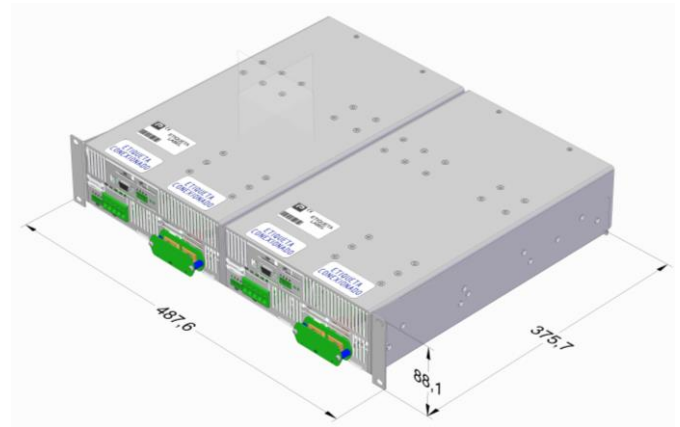



RS232 communications	Comunicaciones RS232
Configuration: 9600 bauds, parity none, 8 bits, 1bit stop Protocol in ASCII code	Configuración: 9600 baudios, sin paridad, 8 bits, 1bit stop Protocolo en código ASCII

Header	Function	Parameter	Returns	Explanation	Explicación			
L		V	PTV####	Input voltage in Volts	Tensión de entrada en Voltios			
		v	PTv####	Input voltage ripple in Volts	Rizado de tensión de entrada en Voltios			
		U	PTURS=####[13]JUST=####[13] UTR=####	Output voltage in Volts RMS ([13] = char 13 of ASCII code)	Tensión de salida en Voltios RMS ([13] = carácter 13 del código ASCII)			
		I	PTIR=####[13]IS=####[13] IT=####	Output current in Amps RMS ([13] = char 13 of ASCII code)	Corriente de salida en Amperios RMS ([13] = carácter 13 del código ASCII)			
		T	PTT####	Internal temperature in K	Temperatura interna en K			
		F	PTF####	Nominal output frequency in Hz	Frecuencia salida nominal en Hz			
		f	PTf####	Actual output frequency in Hz	Frecuencia salida instantánea en Hz			
		u	PTu####	Actual output voltage set-point in V	Consigna instantánea de tensión de salida en V			
		S	PTS####	Inverter state 999.9 → Enabled 000.0 → Disabled 222.2 → Blocked by overload 111.1 → Blocked by overload or shortcircuit	Estado del ondulador 999.9 → En marcha 000.0 → Parado 222.2 → Bloqueado por sobrecarga 111.1 → Bloqueado por sobrecarga, cortocircuito			
		M	PTM####	Model number	Modelo del producto			
		R	PTR####	Firmware version	Versión del firmware			
		Other	PTE	Command not supported	Comando no soportado			
P	R			1	####	OK / ERR	Set the low input voltage timed shutdown in V	Establece el paro temporiz. por tensión baja en V
				3	####	OK / ERR	Change the status bit (after start up enabled with SW3 =LOCAL and disabled with SW3 =REMOTE) 999.9 → Inverter enabled 000.0 → Inverter disabled	Cambia el bit de estado (después de arranque habilitado con SW3 =LOCAL y deshabilitado con SW3= REMOTE) 999.9 → Ondulador habilitado 000.0 → Ondulador deshabilitado
				4	####	OK / ERR	Set the output voltage in Vrms (Vo) (output must be stopped) 050.0 ≤ #### ≤ 405.0	Establece la tensión de salida (la salida debe de estar parada) 050.0 ≤ #### ≤ 405.0
				5	####	OK / ERR	Set the maximum output current in Arms 20% I _{nom} ≤ #### ≤ 100% I _{nom}	Establece la corriente máxima de salida 20% I _{nom} ≤ #### ≤ 100% I _{nom}
				6	####	OK / ERR	Set the nominal output frequency in Hz (Fo) (output must be stopped) 016.0 ≤ #### ≤ 075.0	Establece la frecuencia nominal de salida (Fo) (la salida debe de estar parada) 016.0 ≤ #### ≤ 075.0
				7	####	OK / ERR	Set the alarm maximum output current 0 < #### ≤ 100% I _{max_warning}	Establece la corriente máxima de alarma 0 < #### ≤ 100% I _{max_alarma}
				8	####	OK / ERR	111.1 → Reset the inverter	111.1 → Reinicializa el ondulador
				L	####	OK / ERR	Set the minimum input starting voltage in Volts	Establece la tensión de entrada mínima de arranque en Voltios
				O	####	OK / ERR	Set the initial frequency in the startup (Fi) 016.0 ≤ #### ≤ 075.0	Establece la frecuencia inicial del arranque (Fi) 016.0 ≤ #### ≤ 075.0
				P	####	OK / ERR	Set the ramp-up in increment of "N" cycles per Hz in mode V/F, frequency changes or start-up (Note-1) 001.0 ≤ #### ≤ 100.0	Establece la pendiente de cambio ascendente en incremento de "N" ciclos por Hz en modo V/F, cambios de frecuencia o durante el arranque 001.0 ≤ #### ≤ 100.0
				Q	####	OK / ERR	Set the ramp-down in decrement of "N" cycles per Hz in mode V/F (Note-1) 002.0 ≤ #### ≤ 100.0	Establece la pendiente de cambio descendente en decremento de "N" ciclos por Hz en modo V/F 002.0 ≤ #### ≤ 100.0
				M				1
2	####	OK / ERR	Set a new output voltage in Volts (output must be run) 050.0 ≤ #### ≤ 405.0					Establece una nueva tensión de salida en Voltios (la salida debe de estar en marcha) 050.0 ≤ #### ≤ 405.0
3	####	OK / ERR	Set a new output frequency in Hz in mode V/F (output must be run) 016.0 ≤ #### ≤ 075.0					Establece una nueva frecuencia de salida en Hz en modo V/F (la salida debe de estar en marcha) 016.0 ≤ #### ≤ 075.0
4	####	OK / ERR	Changes the output phase order 111.1 → Phase RST (direct phase) 222.2 → Phase SRT (reverse phase)					Cambia el orden de las fases de salida 111.1 → Fase RST (fase directa) 222.2 → Fase SRT (inversión de fase)

Note1:

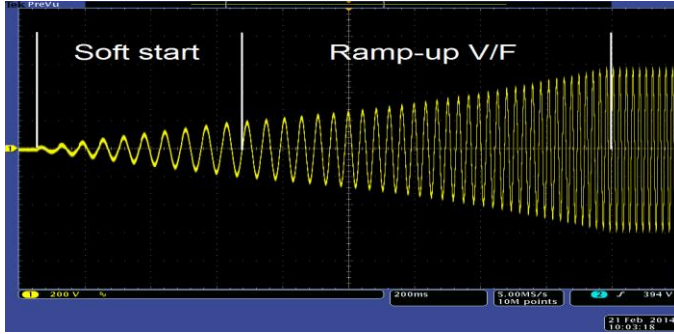

Example for N=1: start-up time = N x 1.7s for changes from 16Hz to 50Hz

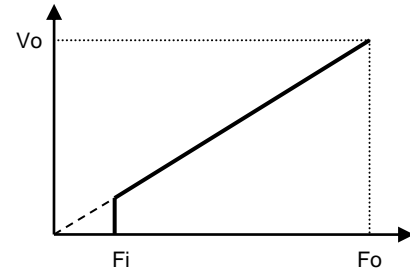

Mode V/F curve

PARÁMETROS DE FUNCIONAMIENTO POR DEFECTO / DEFAULT WORKING PARAMETERS

Protección térmica		Thermal protection		7403...7417					
Temp. interna de alarma (alarma de salida)	Internal warning temperature (output alarm)	88					°C		
Temperatura interna de paro	Internal shutdown temperature	92					°C		
Temperatura interna de re-arranque	Internal restart temperature	75					°C		
Temperatura de arranque de ventilador	Internal temperature of fan start-up	45					°C		
Parámetros tensión entrada		Input voltage parameters		7403 7413	7404	7405	7406	7407 7417	
Tensión alta de paro instantáneo	High input voltage shutdown instantaneous	31.2	46.8	62.4	93.6	143.0	Vdc		
Tensión alta de paro temporizado (t) (Alarma de entrada)	High input voltage timed shutdown (t) (Input alarm)	30.0	45.0	60.0	90.0	137.5	Vdc		
Tensión de arranque	Start-up voltage	19.2	28.8	38.4	57.6	88.0	Vdc		
Tensión baja de paro temporizado (t) (Alarma de entrada)	Low input voltage timed shutdown (t) (Input alarm)	16.8	25.2	33.6	50.4	77.0	Vdc		
Tensión baja de paro instantáneo	Low input voltage instantaneous shutdown	14.4	21.6	28.8	43.2	66.0	Vdc		
Temporización hasta el paro (t)	Time to shutdown (t)	500					ms		
Parámetros tensión de salida		Output voltage parameters		7403...7407		7413 .. 7417			
Tensión de salida	Output voltage	400		230		Vac			
Tensión de salida de paro por sub-tensión	Output under-voltage shutdown	< 85% of setting 1000ms							
Tensión de alarma (alarma de salida)	Warning voltage (output alarm)	<90% of setting 200ms							
Frecuencia de arranque inicial	Initial start-up frequency	16					Hz		
Duración del arranque suave	Soft start duration	10 cycles							
Rampa de subida V/F	Ramp-up V/F	1 Hz/cycle							
Parámetros corriente de salida		Output current parameters		7403	7404..7407	7413	7414..7417		
Corriente máxima continua	Maximum continuous output current	3.46	4.33	6.30	7.55	A			
Corriente de alarma (alarma de salida)	Warning current (output alarm)	3.46	4.33	6.30	7.55	A			
I ² t máximo de sobrecarga	Maximum overload I ² t	See figure below							
Tiempo entre intentos de arranque	Time between restart attempts	4000					ms		
Número de intentos de sobrecarga	Number of attempts of consecutive overload	5							
Fallos de funcionamiento y reset		Working failures and reset		7403...7417					
Enclavamiento ante sobrecargas permanentes o fallos de funcionamiento	Lock for continuous overload or internal failure	Unlimited time							
Tiempo de reset por desconexión de entrada	Reset time by input disconnection	>2					min		

Parámetros configurables subrayados

Configurable parameters underlined

PROTECCIÓN CONTRA SOBRECARGAS / OVERLOAD PROTECTION

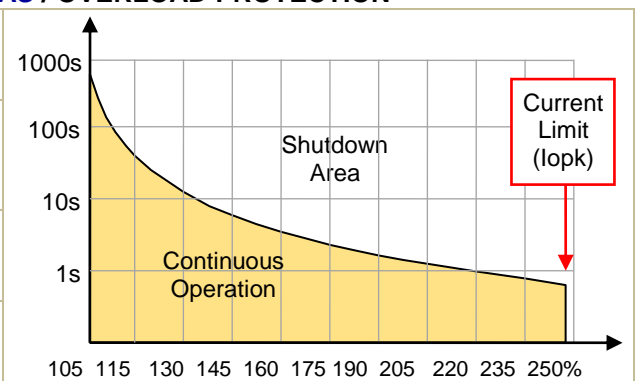
Protección contra sobrecargas y cortocircuitos	Por la limitación de corriente a I _{opk} Por I ² t. La unidad se para cuando el tiempo supera la curva de funcionamiento continuo	
Recuperación de la protección de sobrecarga	Cada 4 segundos después de la parada, la unidad intenta reiniciar hasta 5 veces. Si la sobrecarga persiste, la unidad permanece apagada hasta que una reconexión de entrada.	
Protection against overloads and short-circuits	By current limiting at I _{opk} By I²t . The unit shutdowns when the current-time is over the continuous operation curve	
Overload protection recovery	Every 4 seconds after shutdown, the unit tries to restart up to 5 times. If the overload persists, the unit reminds shutdown until an input reconnection .	



DECLARACIÓN DE CONFORMIDAD UE



EU DECLARATION OF CONFORMITY

El abajofirmante, enrepresentación de /The undersigned, representing the following:

Fabricante / Manufacturer: PREMIUM, S. A.,

Dirección / Address: C/. DolorsAleu 19-21, 2º 2ª 08908 L'Hospitalet de Llobregat, SPAIN

declara que elproducto/ herewith declares that the product:

Tipo/Type: Ondulador CC/CA / DC/AC Inverter

Modelos/ Models: **ODX-3000 -7403 -7404 -7405 -7406 -7407 -7413**

es conforme con las disposiciones de las siguientes directivas UE:

is in conformity with the provisions of the following EU directive(s):

2014/35/EU	Baja tensión	Low voltage
2014/30/EU	Compatibilidad electromagnética	Electromagnetic compatibility

y se han aplicado las normas y/o especificaciones técnicas siguientes:

and that standards and/or technical specifications referenced overleaf have been applied:

EN 60950: 2005	Seguridad (Equipos de tratamiento de la información)	Safety (Information technology equipment)
EN 61000-6-3: 2007	Norma genérica de emisión	Generic emission standard
EN 61000-6-2: 2005	Norma genérica de inmunidad	Generic Immunity standard
EN 50155: 2007*	Aplicaciones ferroviarias. Equipos electrónicos utilizados sobre material rodante	Railway applications. Electronic equipment used on rolling stock material
EN 50121-3-2: 2016*	Aplicaciones ferroviarias. CEM de material rodante. Aparatos	Railway applications. EMC Rolling stock equipment

* Opcional ver anexo / * Optionalseeannex

Año del marcado CE / CE marking year: **2013**

Notas/ Notes:

Para el cumplimiento de esta declaración el producto debe usarse sólo para el fin que ha sido concebido, teniendo en cuenta las limitaciones establecidas en el manual de instrucciones o ficha técnica.

For the fulfilment of this declaration the product must be used only for the aim that has been conceived, considering the limitations established in the instructions manual o data sheet.

L'Hospitalet de Llobregat, 04-01-2018

Jordi Gazo

Director Gerente / Managing Director

PREMIUM S.A. is an ISO9001certified company by**Bureau Veritas**

ANEXO / ANEXE

Valores aplicables para los apartados de la norma EN50155: 2007 Applicable values for the different sections of the norm EN50155: 2007																																																				
4.1.1	Altitud de trabajo Working altitude	According EN50125-1:2003 Class A2 (up to 1000m)																																																		
4.1.2	Temperatura ambiente Ambient temperature	Class T1 column 2 full load Class T2 column 2 50% load																																																		
4.1.3	Choques y vibraciones Shocks and vibrations	According EN61373:2010 Category 1 class B																																																		
4.1.4	Humedad relativa Relative humidity	Up to 95%																																																		
5.1.1.1	Variaciones de la tensión de alimentación Power supply voltage variations	From 0.70 to 1.25 <i>Un</i> continuous From 0.60 to 1.40 <i>Un</i> 0.1s From 1.25 to 1.40 <i>Un</i> 1s without damage																																																		
5.1.1.2	Interrupciones de la tensión de alimentación Power supply interruptions	Class S1 (without interruptions)																																																		
5.1.1.4	Factor de ondulación a la entrada Input ripple factor	Up to 15%peak to peak of <i>Vin</i> nom																																																		
5.1.3	Conmutación de la alimentación Power supply switching	Class C1 (0.6 <i>Un</i> during 100ms without interruptions)																																																		
5.2	Sobretensiones de alimentación Power supply over-voltages	1.40 <i>Un</i> 1s (impedance 1 ohm)																																																		
5.5	CEM Compatibilidad electromagnética EMC Electromagnetic Compatibility EN50121-3-2:2016	<table border="1"> <thead> <tr> <th>Test</th> <th>Norm</th> <th>Port</th> <th>Frequency</th> <th>Limits</th> </tr> </thead> <tbody> <tr> <td rowspan="4">Radiated emissions</td> <td rowspan="4">IEC55016</td> <td rowspan="4">Enclosure</td> <td>30MHz...230MHz</td> <td>40dB(μV/m) Qpk at 10m</td> </tr> <tr> <td>230MHz...1GHz</td> <td>47dB(μV/m) Qpk at 10m</td> </tr> <tr> <td>1...3GHz</td> <td>Do not apply</td> </tr> <tr> <td>3...6GHz</td> <td>Internal freq. < 108MHz</td> </tr> <tr> <td rowspan="2">Conducted emissions</td> <td rowspan="2">IEC55016</td> <td rowspan="2">Input</td> <td>150kHz...500kHz</td> <td>99dB(μV) Qpk</td> </tr> <tr> <td>500kHz...30MHz</td> <td>93dB(μV) Qpk</td> </tr> </tbody> </table>	Test	Norm	Port	Frequency	Limits	Radiated emissions	IEC55016	Enclosure	30MHz...230MHz	40dB(μV/m) Qpk at 10m	230MHz...1GHz	47dB(μV/m) Qpk at 10m	1...3GHz	Do not apply	3...6GHz	Internal freq. < 108MHz	Conducted emissions	IEC55016	Input	150kHz...500kHz	99dB(μV) Qpk	500kHz...30MHz	93dB(μV) Qpk																											
		Test	Norm	Port	Frequency	Limits																																														
		Radiated emissions	IEC55016	Enclosure	30MHz...230MHz	40dB(μV/m) Qpk at 10m																																														
					230MHz...1GHz	47dB(μV/m) Qpk at 10m																																														
					1...3GHz	Do not apply																																														
					3...6GHz	Internal freq. < 108MHz																																														
		Conducted emissions	IEC55016	Input	150kHz...500kHz	99dB(μV) Qpk																																														
					500kHz...30MHz	93dB(μV) Qpk																																														
		<table border="1"> <thead> <tr> <th>Test</th> <th>Norm</th> <th>Port</th> <th>Severity</th> <th>Conditions</th> <th>P</th> </tr> </thead> <tbody> <tr> <td rowspan="2">Electrostatic discharge</td> <td rowspan="2">IEC61000-4-2</td> <td rowspan="2">Enclosure</td> <td>±8kV</td> <td>Air (isolated parts)</td> <td rowspan="2">B</td> </tr> <tr> <td>±6kV</td> <td>Contact (conductive parts)</td> </tr> <tr> <td rowspan="4">Radiated high-frequency</td> <td rowspan="4">IEC61000-4-3</td> <td rowspan="4">X/Y/Z Axis</td> <td>20V/m</td> <td>0.08...1GHz M. 80% 1kHz</td> <td rowspan="4">A</td> </tr> <tr> <td>10V/m</td> <td>1...2GHz M. 80% 1kHz</td> </tr> <tr> <td>5V/m</td> <td>2...2.7GHz M. 80% 1kHz</td> </tr> <tr> <td>3V/m</td> <td>5.1...6Ghz M. 80% 1kHz</td> </tr> <tr> <td rowspan="3">Fast transients</td> <td rowspan="3">IEC61000-4-4</td> <td>Input</td> <td rowspan="3">±2kV</td> <td rowspan="3">Tr/Th: 5/50 ns</td> <td rowspan="3">A</td> </tr> <tr> <td>Output</td> </tr> <tr> <td>Signal</td> </tr> <tr> <td rowspan="2">Surge</td> <td rowspan="2">IEC61000-4-5</td> <td>Input L to L</td> <td rowspan="2">±1kV</td> <td rowspan="2">Tr/Th: 1.2/50μs</td> <td rowspan="2">B</td> </tr> <tr> <td>Input L to P</td> <td>±2kV</td> </tr> <tr> <td rowspan="3">Conducted RF</td> <td rowspan="3">IEC61000-4-6</td> <td>Input</td> <td rowspan="3">10V</td> <td rowspan="3">0.15...80MHz M. 80% 1kHz</td> <td rowspan="3">A</td> </tr> <tr> <td>Output</td> </tr> <tr> <td>Signal</td> </tr> </tbody> </table>	Test	Norm	Port	Severity	Conditions	P	Electrostatic discharge	IEC61000-4-2	Enclosure	±8kV	Air (isolated parts)	B	±6kV	Contact (conductive parts)	Radiated high-frequency	IEC61000-4-3	X/Y/Z Axis	20V/m	0.08...1GHz M. 80% 1kHz	A	10V/m	1...2GHz M. 80% 1kHz	5V/m	2...2.7GHz M. 80% 1kHz	3V/m	5.1...6Ghz M. 80% 1kHz	Fast transients	IEC61000-4-4	Input	±2kV	Tr/Th: 5/50 ns	A	Output	Signal	Surge	IEC61000-4-5	Input L to L	±1kV	Tr/Th: 1.2/50μs	B	Input L to P	±2kV	Conducted RF	IEC61000-4-6	Input	10V	0.15...80MHz M. 80% 1kHz	A	Output	Signal
		Test	Norm	Port	Severity	Conditions	P																																													
Electrostatic discharge	IEC61000-4-2	Enclosure	±8kV	Air (isolated parts)	B																																															
			±6kV	Contact (conductive parts)																																																
Radiated high-frequency	IEC61000-4-3	X/Y/Z Axis	20V/m	0.08...1GHz M. 80% 1kHz	A																																															
			10V/m	1...2GHz M. 80% 1kHz																																																
			5V/m	2...2.7GHz M. 80% 1kHz																																																
			3V/m	5.1...6Ghz M. 80% 1kHz																																																
Fast transients	IEC61000-4-4	Input	±2kV	Tr/Th: 5/50 ns	A																																															
		Output																																																		
		Signal																																																		
Surge	IEC61000-4-5	Input L to L	±1kV	Tr/Th: 1.2/50μs	B																																															
		Input L to P				±2kV																																														
Conducted RF	IEC61000-4-6	Input	10V	0.15...80MHz M. 80% 1kHz	A																																															
		Output																																																		
		Signal																																																		
P= Performance criteria, L= Line, P= PE (Protective Earth)																																																				
7.2.6	Protección inversión de polaridad de entrada Input reverse polarity protection	By external fuse																																																		
9.7	Recubrimiento de protección del PCB PCB protection	PCB conformal coated																																																		
12.2	Lista de ensayos Tests list	1 Visual Inspection 2 Performance 3 Cooling 4 Dry heat 6 Supply overvoltages 7 Surge, ESD and burst susceptibility 8 RF Interferences 9 Insulation 11 Shocks and vibrations 13 Equipment stress screening:24h at 40°C and load 100% 14 Low temperature storage Routine Routine Type Type Type Type Type Routine Type Routine Type																																																		